

600V/30A IGBT 3 phase DC/AC inverte

IPM DIP-25

MAIN FUNCTION

- Integrated drive: High voltage (600V) high-speed level shifting, Control supply under-voltage (UV) protection, Short circuit protection (SC)
- Input interface: 3, 5V line, Schmitt trigger receiver circuit (High Active)
- Temperature output: Outputting LVIC temperature by analog signal
- Lower axle arm output
- Low loss 3 phase DC/AC inverter circuit
- Built-in bootstrap diodes with current limiting resistor

APPLICATION

- Compressor of air conditioner and refrigerator
- Low power frequency converter

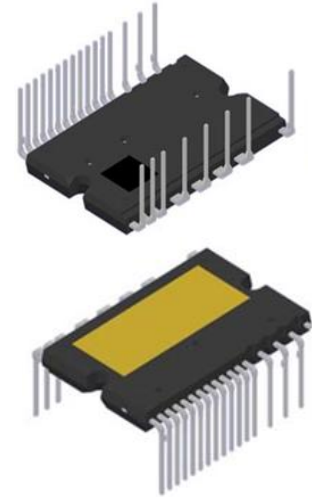

INTERNAL CIRCUIT

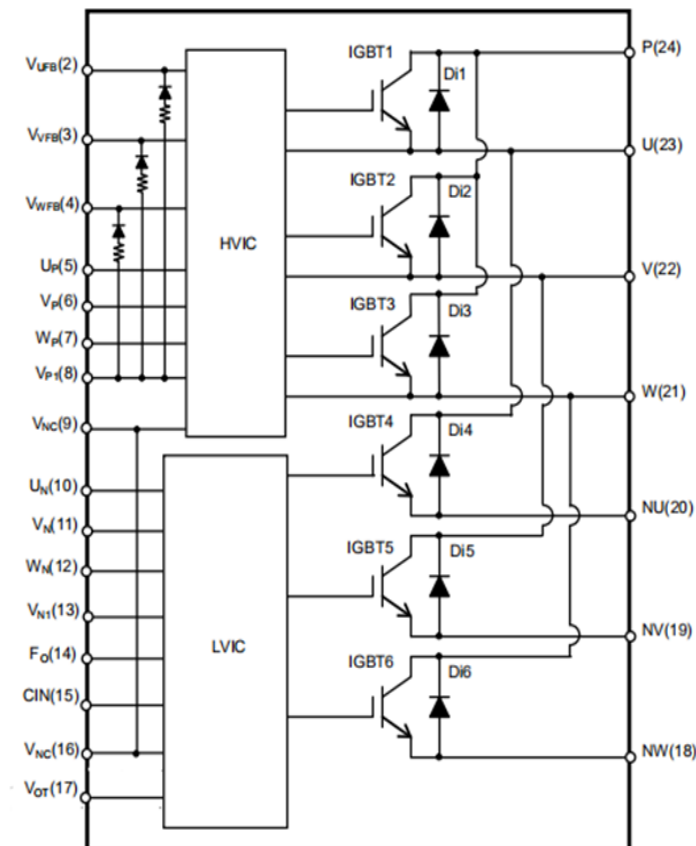

Fig. 1 internal circuit

Num	Name	Description
1	NC	Non
2	V _{UFB}	U phase upper bridge drive supply
3	V _{VFB}	V phase upper bridge drive supply
4	V _{WFB}	W phase upper bridge drive supply
5	U _P	U phase upper bridge control input
6	V _P	V phase upper bridge control input
7	W _P	W phase upper bridge control input
8	V _{P1}	Control supply
9	V _{NC}	GND
10	U _N	U phase lower bridge control input
11	V _{NC}	V phase lower bridge control input
12	W _N	W phase lower bridge control input
13	V _{N1}	Control supply
14	F _O	Fault output
15	C _{IN}	Short circuit protect
16	V _{NC}	GND
17	V _{OT}	Temperature Output
18	NW	U phase lower bridge output
19	NV	V phase lower bridge output
20	NU	W phase lower bridge output
21	W	U phase output
22	V	V phase output
23	U	W phase output
24	P	DC input
25	NC	Non

Fig. 2 Pin name

MAXIMUM RATINGS (T_j = 25°C, unless otherwise noted)
INVERTER PART

Symbol	Parameter	Condition	Ratings	Unit
V _{CC}	Supply voltage	Applied between P-NU,NV,NW	450	V
V _{CC(surge)}	Supply voltage (surge)	Applied between P-NU,NV,NW	500	V
V _{CES}	Collector-emitter voltage		600	V
±I _C	Each IGBT collector current	TC= 25°C	30	A
±I _{CP}	Each IGBT collector current (peak)	TC= 25°C, less than 1ms	60	A
P _C	Collector dissipation	TC= 25°C, per 1 chip	80	W

CONTROL (PROTECTION) PART

Symbol	Parameter	Condition	Ratings	Unit
V _D	Control supply voltage	Applied between V _{P1} -V _{NC}	17.5	V
V _{DB}	Control supply voltage	Applied between V _{UFB} -V, V _{VFB} -V, V _{WFB} -V	17.5	V
V _{IN}	Input voltage	Applied between U _P , V _P , W _P , U _N , V _N , W _N -V _{NC}	-1~ 10	V
V _{FO}	Fault output supply voltage	Applied between F _O -V _{NC}	-0.5~ V _D +0.5	V
I _{FO}	Fault output current	Sink current at F _O terminal	1.5	mA
V _{SC}	Current sensing input voltage	Applied between CIN-V _{NC}	-0.5~ V _D +0.5	V

TOTAL SYSTEM

Symbol	Parameter	Condition	Ratings	Unit
V _{CC(PROT)}	Self protection supply voltage limit	V _D = 14.5~17.5V, Inverter Part	400	V
T _C	(Short circuit protection capability)	T _j = 125°C, non-repetitive, less than 2μs	-20~+100	°C
T _{sig}	Module case operation temperature	Measurement point of T _c is provided in Fig.1	-40~+125	°C
V _{iso}	Storage temperature		1500	Vrms
R _{th(j-c)Q}	Junction to case thermal resistance (Note 2)	single IGBT	3	°C/W
R _{th(j-c)F}		single FRD	5.0	°C/W

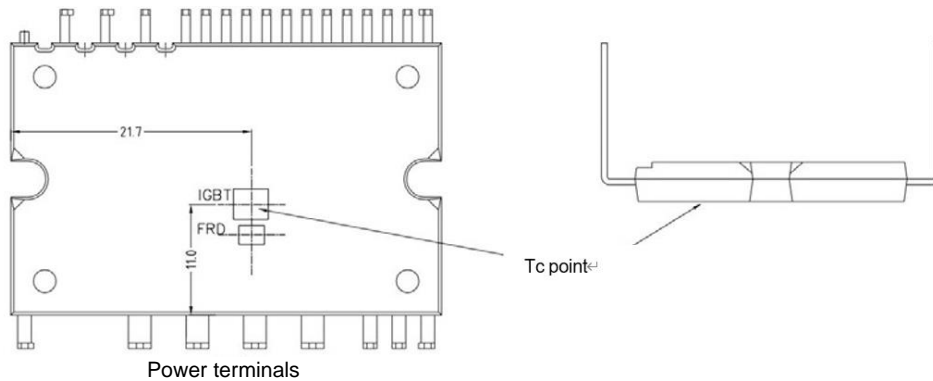

Fig. 3 TC measurement point

THERMAL RESISTANCE(T_j = 25°C, unless otherwise noted)
INVERTER PART

Symbol	Parameter	Condition	Min	Typ	Max	Unit
V _{CE(sat)}	Collector-emitter saturation voltage	V _D =V _{DB} =15V I _C =30A V _{IN} =5V	-	2.1	2.6	V
V _F	FWD forward voltage	I _C =-30A V _{IN} =0V	-	1.6	2.0	V
I _{CES}	Collector-emitter leakage current	V _{CE} = V _{CES}	-	-	100	uA
t _{ON}	Switching times	V _{CC} =300V V _D =V _{DB} =15V I _C =30 V _{IN} =0-5V R _θ =10Ω Inductive Load	-	1.1	-	us
t _{C(ON)}			-	0.5	-	us
t _{OFF}			-	0.65	-	us
t _{C(OFF)}			-	0.1	-	us
t _{rr}			-	0.27	-	us
E _{on}	Turn-on switching loss		-	2.2	-	mJ
E _{off}	Turn-off switching loss		-	0.44	-	mJ

t_{ON}、t_{OFF} include internal transmission delay time of driving IC.

t_{C(ON)}、t_{C(OFF)} Is the switching time of IGBT under the internal given gate level driving conditions.

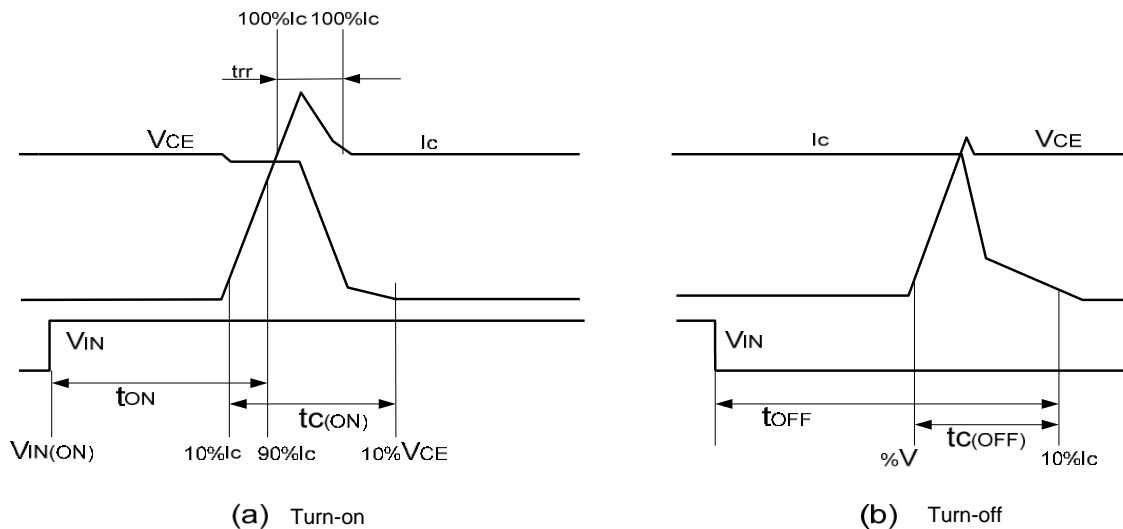

Fig. 4 switch time

CONTROL (PROTECTION) PART

Symbol	Parameter	Condition		Min.	Typ.	Max.	Unit
I _D	V _D static current	V _D =15V V _{IN} =5V	V _{P1} -V _{NC}	-	0.35	0.8	mA
I _{DB}	V _{DB} static current	V _{DB} =15V V _{IN} =5V	V _{UFB} -U, V _{VFB} -V, V _{WFB} -W	-	100	200	uA

V_{FOH}	Fault output voltage	$V_{SC}=0V$, FO pin is pulled up to 5V through 10K resistance	4.6	-	-	V
V_{FOL}		$V_{SC}=1V$, $I_{FO}=1.5mA$	-	-	0.3	V
$V_{SC,TH+}$	Short circuit trip level (forward)	$V_D=15V$	0.37	0.47	0.65	V
$V_{SC,TH-}$	Short circuit trip level (reverse)	$V_D=15V$	0.2	0.4	-	V
UV_{DR}	supply under-voltage protection (UV)	Reset level	10	11.3	12	V
UV_{DD}		Trip level	9	10.2	11	
UV_{DBR}		Reset level	10	11.3	12	
UV_{DBD}		Trip level	9	10.2	11	
$R_{on,FLT}$	Fault low effective resistance	$I=1.5mA$		50	90	Ω
T_{FO}	Fault output pulse width		40	65	120	us
$t_{FIL,IN}$	Input signal delay time $U_P, V_P, W_P, U_N, V_N, W_N$	$V_{IN}=0V$ & $5V$	140	290		ns
t_{CINMIN}	CIN input signal delay time	$V_{IN}=0V$ or $5V, V_{CIN}=5V$	270	530	780	ns
$V_{IN(ON)}$	ON threshold voltage	Applied between $U_P, V_P, W_P, U_N, V_N, W_N$		2.1	2.5	V
$V_{IN(OFF)}$	Off threshold voltage	$-V_{NC}$	0.8	1.2		
V_{OT}	Temperature output (note 3)	$T_C=90^\circ C$	2.63	2.77	2.91	V
		$T_C=25^\circ C$	0.88	1.13	1.39	

Note 3: IPM don't shutdown IGBTs and output fault signal automatically when temperature rises excessively. When temperature exceeds the protective level that user defined, controller (MCU) should stop the IPM. Temperature of IPM vs. V_{OT} output characteristics is described in Fig. 5. the curve is the result of 5K pull-down resistance test.

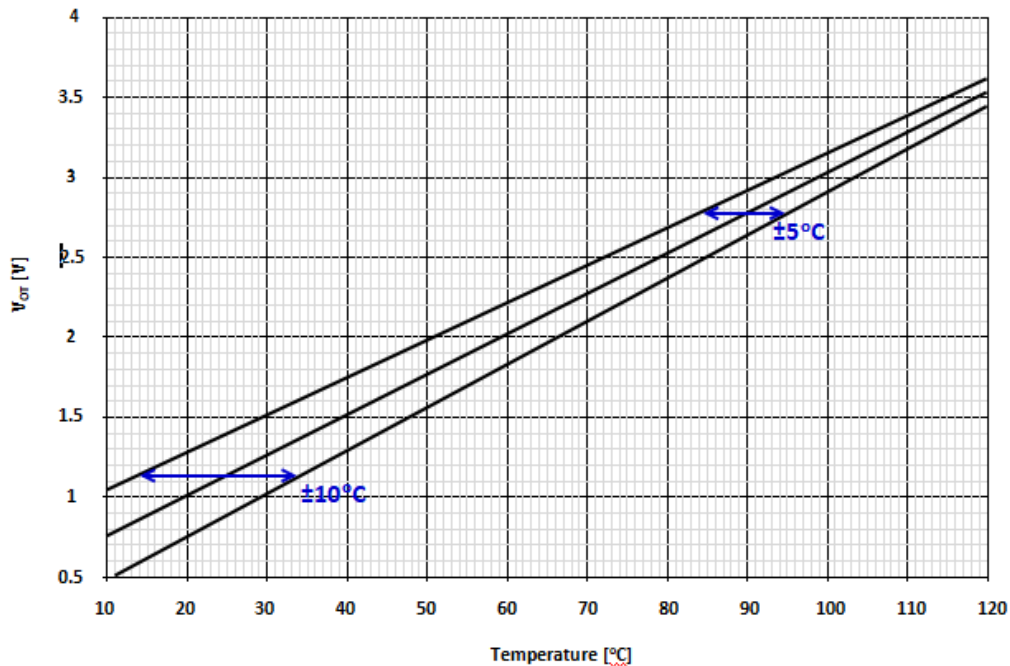

Fig. 5 Temperature of IPM vs. VOT

RECOMMENDED OPERATION CONDITIONS

Symbol	Parameter	Condition	Min.	Typ.	Max.	Unit
V_{CC}	Supply voltage	Applied between P-NU, NV, NW	0	300	400	V
V_D	Control supply voltage	Applied between VP1-VPC, VN1-VN C		15		V
V_{DS}	Upper bridge Control supply voltage	Applied between V_{UFB-U} , V_{VFB-V} , V_{WF} B-W		15		V
t_{dead}	Arm shoot-through blocking time	For each input signal, $T_c \leq 100^\circ\text{C}$	1	-	-	us
f_{PWM}	PWM input frequency	$-20^\circ\text{C} \leq T_c \leq +100^\circ\text{C}$ $-20^\circ\text{C} \leq T_j \leq +150^\circ\text{C}$	-	-	20	kHz
PWM	minimum Input pulse width	ON	0.7		-	us
		OFF	0.7			us
T_j	Junction temperature		-20		125	$^\circ\text{C}$

MECHANICAL CHARACTERISTICS AND RATINGS

Parameter	Condition	Min.	Typ.	Max.	Unit
Mounting torque	Mounting screw : M3	-	0.69	-	N•m
Weight		-	7	-	g

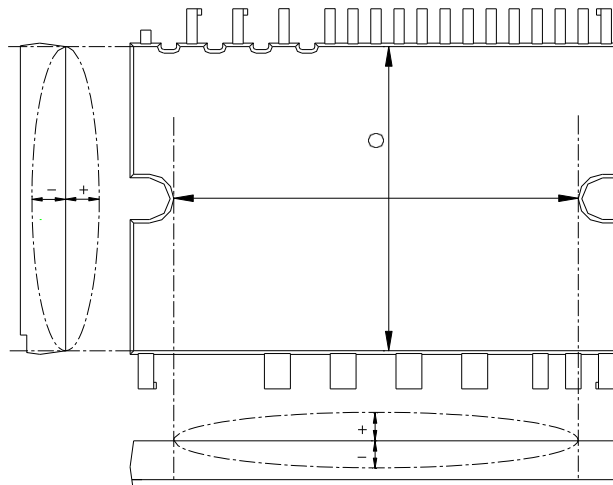

Fig. 6 measurement point of heat sink flatness

Application Guide

Enhanced input filtering

The enhanced filter can improve the consistency of input / output pulses of the internal module of HVIC and help to filter out interference signals and narrow pulses, that is described in Fig. 7.8

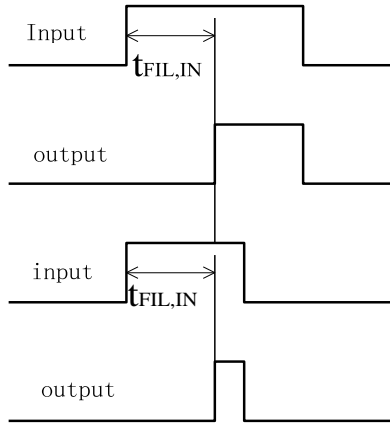

Fig. 7 Type input filtering

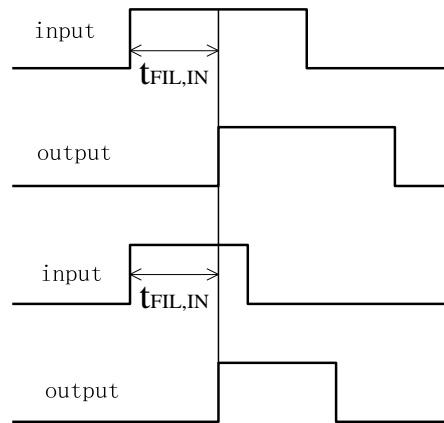

Fig. 8 Enhanced input filtering

Functional sequence diagram

Ho and Lo are internal HVIC gate output signals

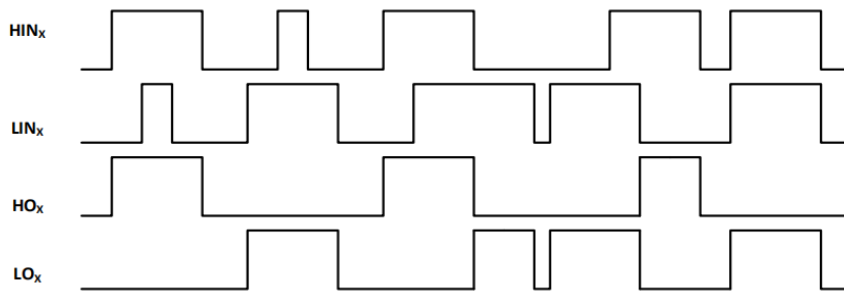

Fig. 9 HVIC gate output

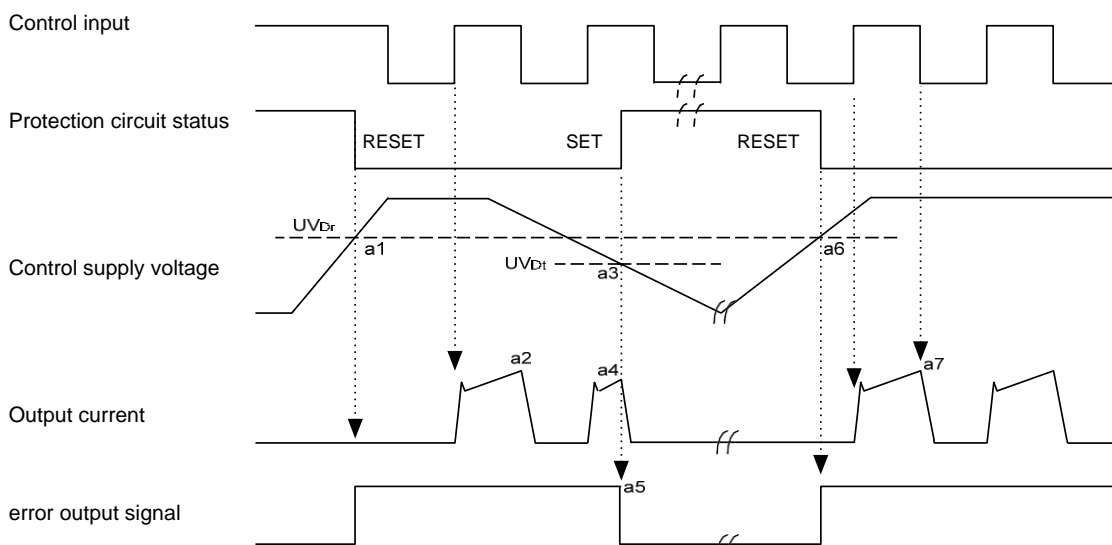

Fig. 10 Under-Voltage Protection

- a1 : Control supply voltage exceeds under voltage reset level(UVDr) : the line will start operation before the next undervoltage signal is executed.
- a2 : Normal operation: IGBT ON and outputs current.
- a3 : Voltage level drops to under voltage trip level. (UVDt).
- a4 : All IGBTs turn OFF in spite of control input condition.
- a5 : Error output.
- a6 : Voltage level reaches UVDr.
- a7 : Normal operation: IGBT ON and outputs current.

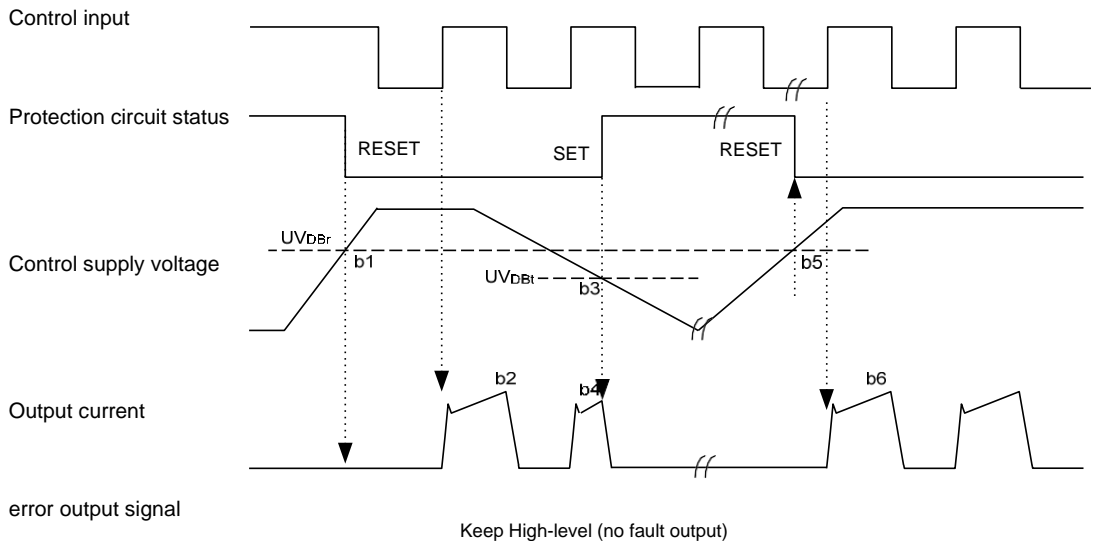

Fig. 11 Under-Voltage Protection

- b1 : Control supply voltage exceeds under voltage reset level(UVDr) : the line will start operation before the next undervoltage signal is executed.
- b2 : Normal operation: IGBT ON and outputs current.
- b3 : Voltage level drops to under voltage trip level (UVDBt).
- b4 : All IGBTs turn OFF in spite of control input condition.
- b5 : Voltage level reaches UVDBr.
- b6 : Normal operation: IGBT ON and outputs current.

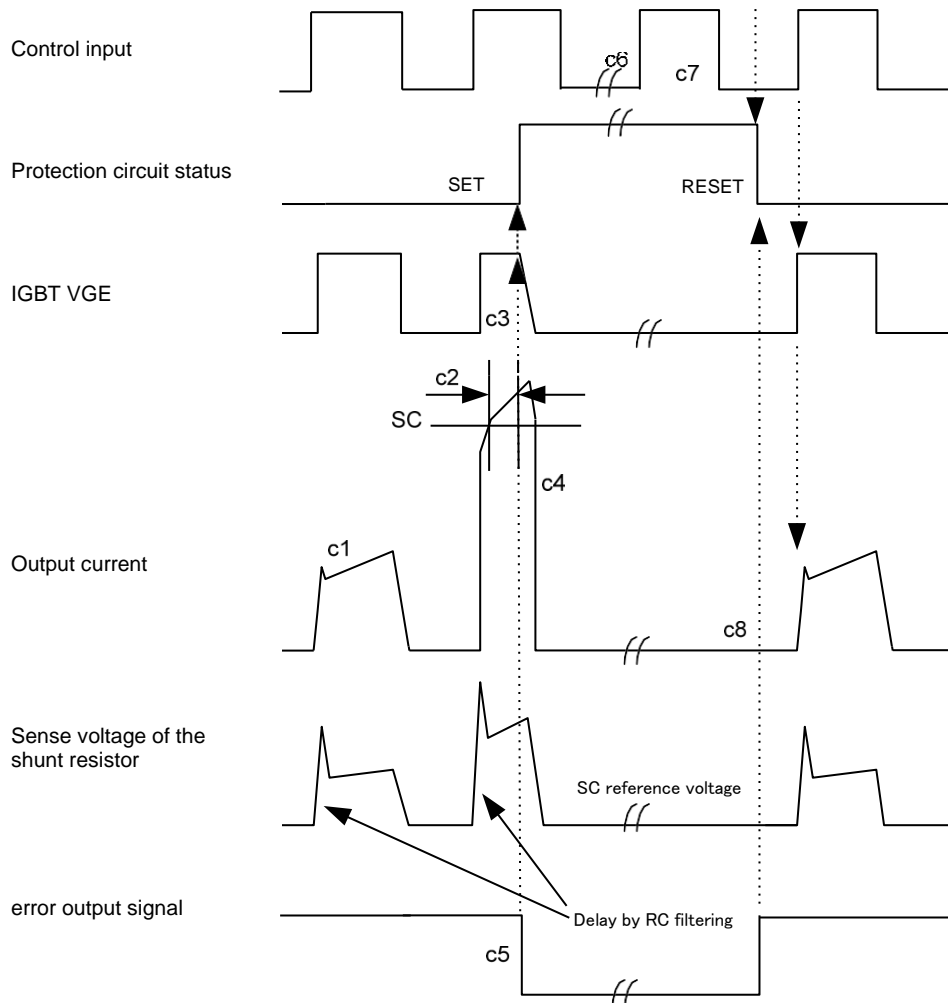

Fig. 12 Short-Circuit Protection

Contact with the external shunt resistor .

c1 : Normal operation: IGBT ON and outputs current.

c2 : Short circuit current detection (CIN trigger).

c3 : IGBT's gates are hard interrupted.

c4 : IGBTs turn OFF.

c5 : The fault output timer starts running: the pulse width of the fault output signal is set by the external capacitor CFO.

c6 : transform "L" : IGBT turn off.

c7 : transform "H" : IGBT turn on, but IGBTs don't turn on before Fo finishes.

c8 : IGBT turn off.

MCU I/O Interface Circuit

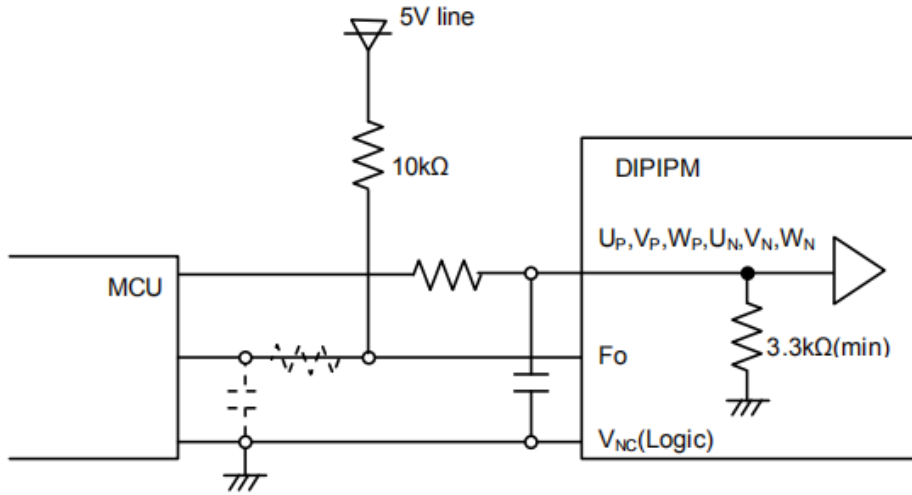

Fig. 13 MCU I/O Interface Circuit

Pattern Wiring Around the Shunt Resistor

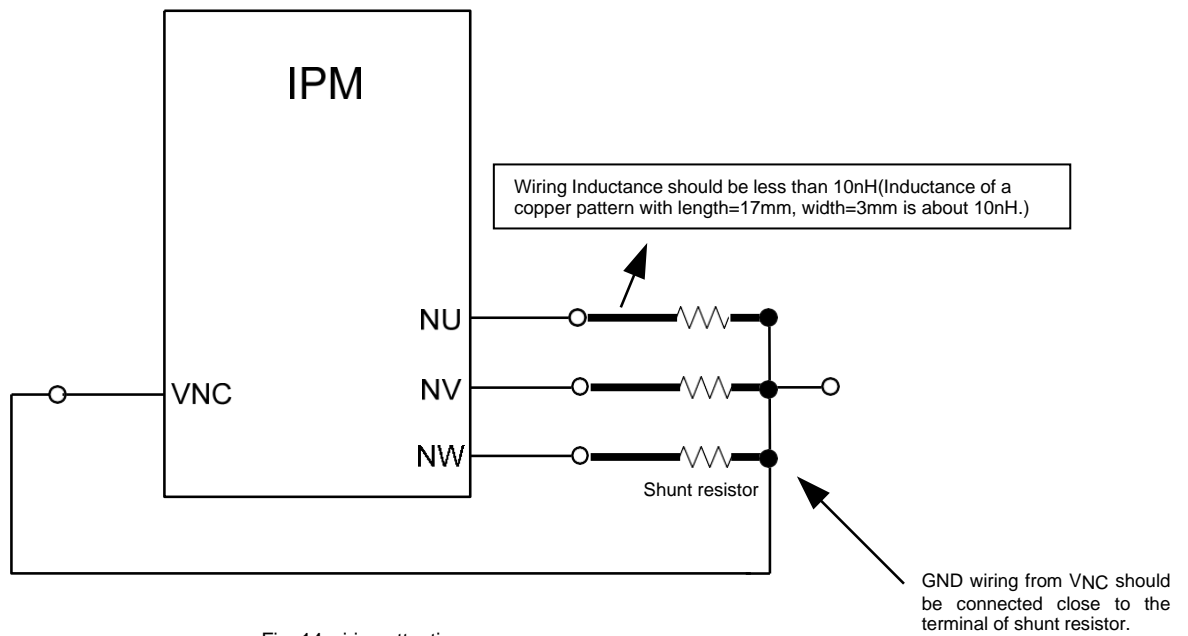

Fig. 14 wiring attention

Example of Application Circuit

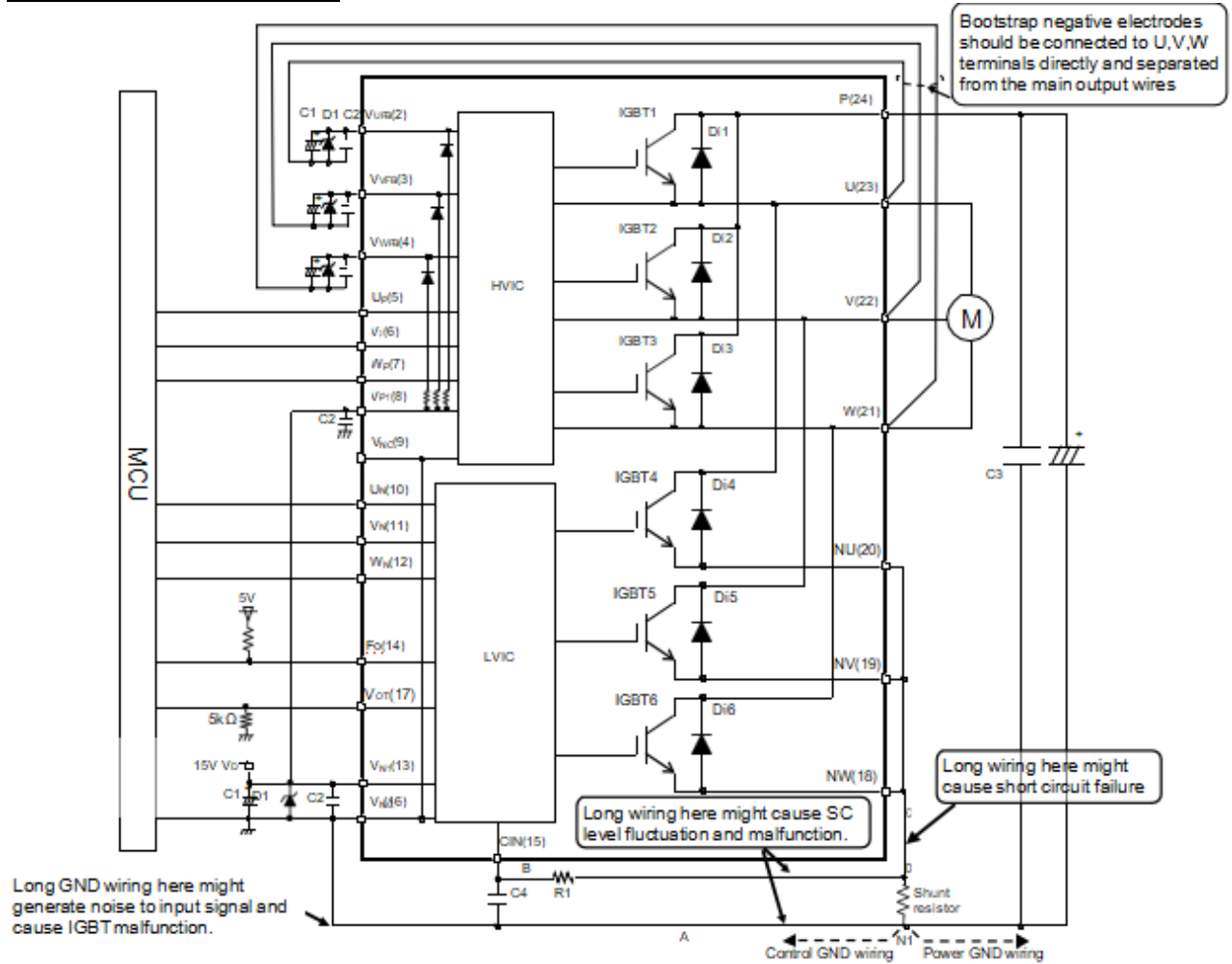

Fig. 15 Example of Application Circuit

Package Outlines

