

IGBT

Features

- 1200V,50A
- $V_{CE(sat)(typ.)}=2.1V@V_{GE}=15V,I_C=50A$
- High speed switching
- Higher system efficiency
- Soft current turn-off waveforms
- Square RBSOA using NPT technology

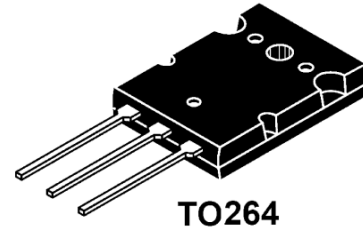

General Description

JIAEN NPT IGBTs offer lower losses and higher energy efficiency for application such as IH (induction heating),UPS, general inverter and other soft switching applications.

Absolute Maximum Ratings

Symbol	Parameter	Value	Units
V_{CES}	Collector-Emitter Voltage	1200	V
V_{GES}	Gate-Emitter Voltage	± 30	V
I_C	Continuous Collector Current ($T_C=25^\circ C$)	80	A
	Continuous Collector Current ($T_C=100^\circ C$)	50	A
I_{CM}	Pulsed Collector Current (Note 1)	150	A
I_F	Diode Continuous Forward Current ($T_C=100^\circ C$)	50	A
I_{FM}	Diode Maximum Forward Current (Note 1)	150	A
t_{sc}	Short Circuit Withstand Time $V_{GE}=15V, V_{CC}\leq 960V, T_J\leq 150^\circ C$;	10	us
P_D	Maximum Power Dissipation ($T_C=25^\circ C$)	320	W
	Maximum Power Dissipation ($T_C=100^\circ C$)	130	W
T_J	Operating Junction Temperature Range	-55 to +150	$^\circ C$
T_{STG}	Storage Temperature Range	-55 to +150	$^\circ C$

Thermal Characteristics

Symbol	Parameter	Max.	Units
$R_{th\ j-c}$	Thermal Resistance, Junction to case for IGBT	0.38	$^\circ C/W$
$R_{th\ j-c}$	Thermal Resistance, Junction to case for Diode	0.5	$^\circ C/W$
$R_{th\ j-a}$	Thermal Resistance, Junction to Ambient	40	$^\circ C/W$

Electrical Characteristics ($T_C=25^\circ\text{C}$ unless otherwise noted)

Symbol	Parameter	Test Conditions	Min.	Typ.	Max.	Units	
BV_{CES}	Collector-Emitter Breakdown Voltage	$V_{GE}=0V, I_C=250\mu A$	1200	-	-	V	
I_{CES}	Collector-Emitter Leakage Current	$V_{CE}=1200V, V_{GE}=0V$	-	-	250	μA	
I_{GES}	Gate Leakage Current, Forward	$V_{GE}=30V, V_{CE}=0V$	-	-	100	nA	
	Gate Leakage Current, Reverse	$V_{GE}=-30V, V_{CE}=0V$	-	-	-100	nA	
$V_{GE(th)}$	Gate Threshold Voltage	$V_{GE}=V_{CE}, I_C=250\mu A$	4.0	-	6.0	V	
$V_{CE(sat)}$	Collector-Emitter Saturation Voltage	$V_{GE}=15V, I_C=50A$	-				
		$T_C=25^\circ\text{C}$		2.1	2.6	V	
		$T_C=125^\circ\text{C}$		2.5		V	
		$T_C=150^\circ\text{C}$		2.8		V	
Q_g	Total Gate Charge	$V_{CC}=960V$	-	170		nC	
Q_{ge}	Gate-Emitter Charge	$V_{GE}=15V$	-	40		nC	
Q_{gc}	Gate-Collector Charge	$I_C=50A$	-	80		nC	
$t_{d(on)}$	Turn-on Delay Time	$V_{CC}=600V$ $V_{GE}=15V$ $I_C=50A$ $R_G=10\Omega$ Inductive Load $T_C=25^\circ\text{C}$	-	50	-	ns	
t_r	Turn-on Rise Time		-	80	-	ns	
$t_{d(off)}$	Turn-off Delay Time		-	280	-	ns	
t_f	Turn-off Fall Time		-	30	-	ns	
E_{on}	Turn-on Switching Loss		-	4.6	-	mJ	
E_{off}	Turn-off Switching Loss		-	2.8	-	mJ	
E_{ts}	Total Switching Loss		-	7.4	-	mJ	
C_{ies}	Input Capacitance		$V_{CE}=30V$	-	4120	-	pF
C_{oes}	Output Capacitance		$V_{GE}=0V$	-	160	-	pF
C_{res}	Reverse Transfer Capacitance	$f=1\text{MHz}$	-	100	-	pF	

Electrical Characteristics of Diode ($T_C=25^\circ\text{C}$ unless otherwise noted)

Symbol	Parameter	Test Conditions	Min.	Typ.	Max.	Units
V_F	Diode Forward Voltage	$I_F=50A$	-	2.3	3.2	V
t_{rr}	Diode Reverse Recovery Time	$V_{CE}=600V$	-	250		ns
I_{rr}	Diode peak Reverse Recovery Current	$I_F=50A$	-	10		A
Q_{rr}	Diode Reverse Recovery Charge	$dI_F/dt=200A/\mu s$	-	1350		nC

Notes:

1. Repetitive Rating: Pulse width limited by maximum junction temperature

Typical Performance Characteristics

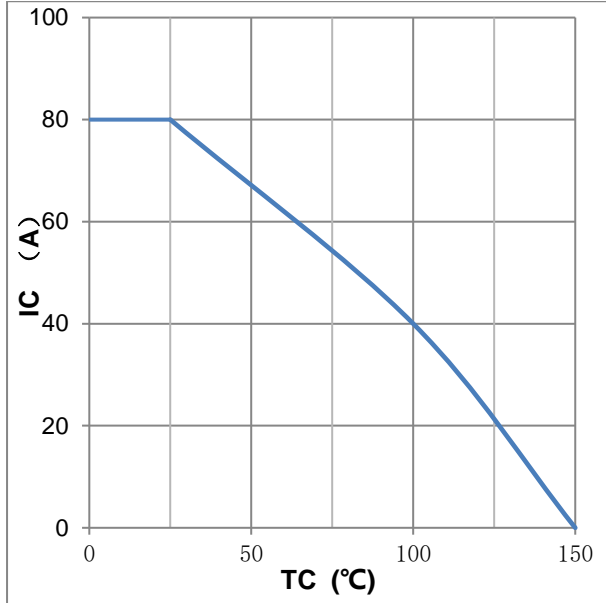

Figure1:maximum DC collector current
VS. case temperature

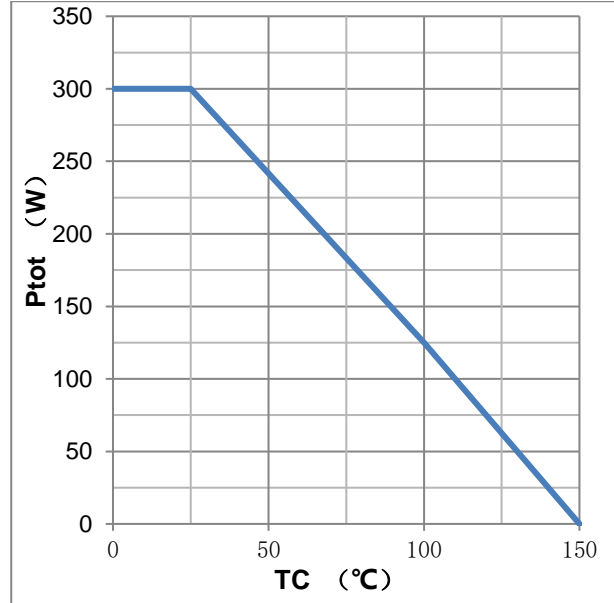

Figure2:power dissipation VS. case temprature

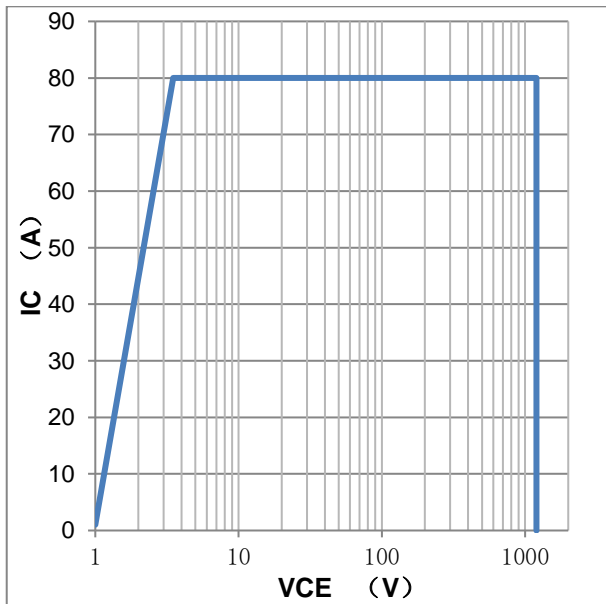

Figure3:reverse bias SOA,TJ=150°C,VGE=15V

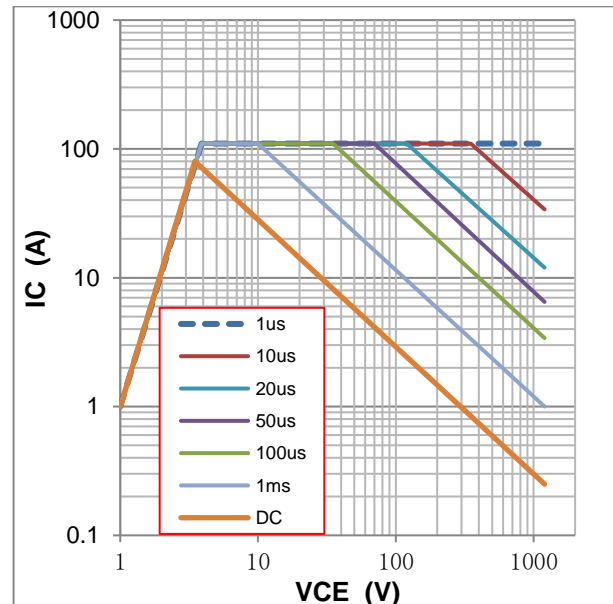

Figure4:forward SOA,TC=25°C,TJ≤150°C

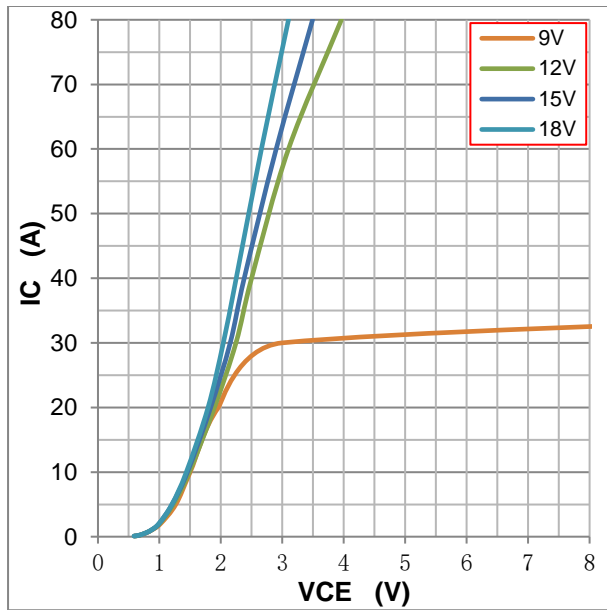

Figure5: typical IGBT output characteristics,
 $T_J=25^{\circ}\text{C}; t_p=300\mu\text{s}$

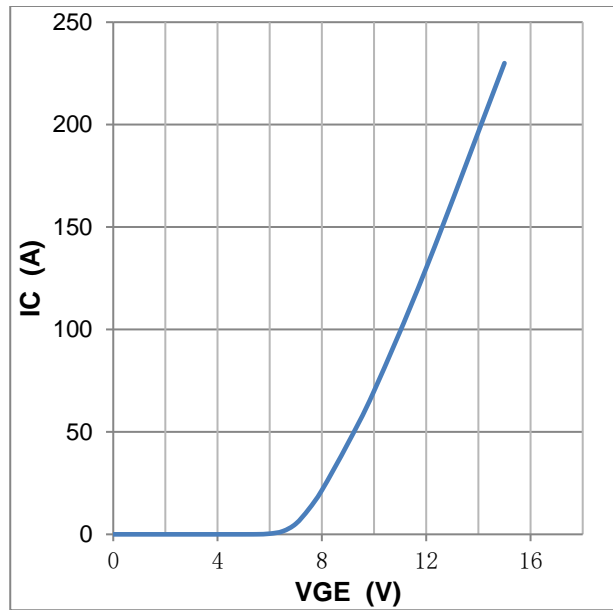

Figure6: typical trans characteristics, $V_{CE}=20\text{V}, t_p=20\mu\text{s}$

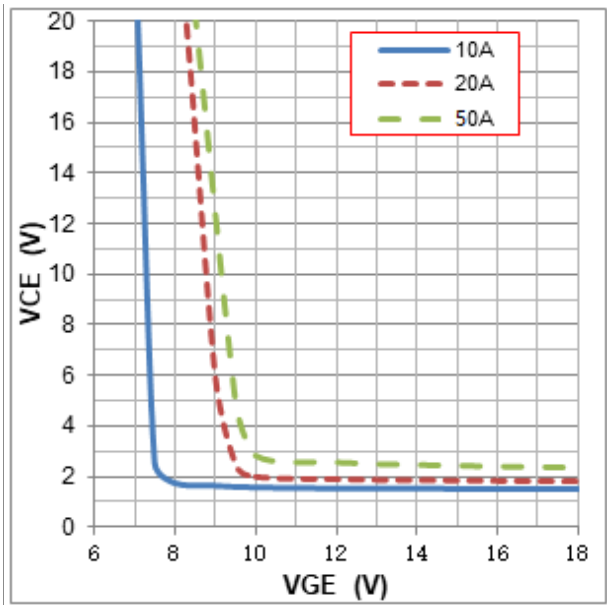

Figure7: typical VCE VS. VGE, $T_J=25^{\circ}\text{C}$

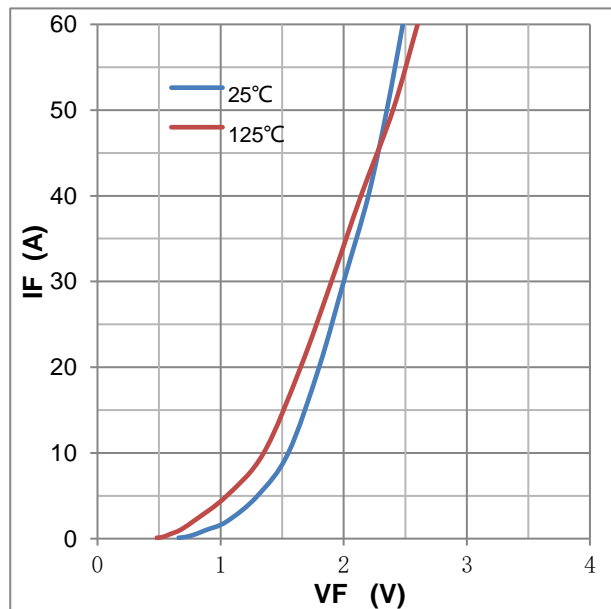

Figure8: typical diode forward characteristic, $t_p=300\mu\text{s}$

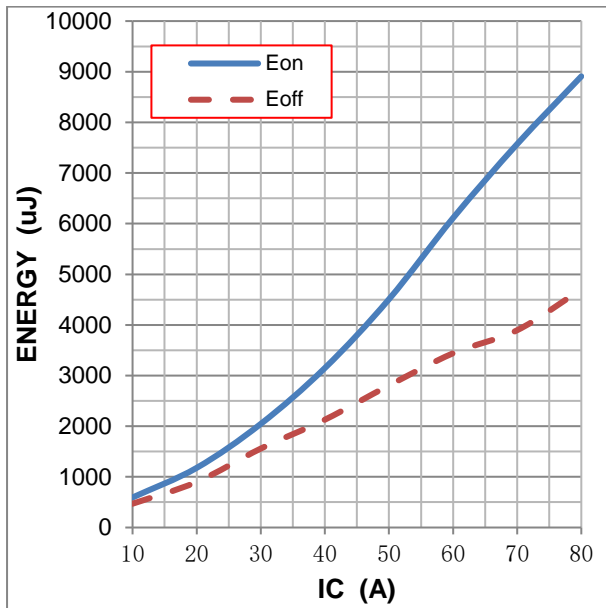

Figure9: typical energy loss VS. IC, TC=25°C,

L=500uH, VCE=600V, VGE=15V, Rg=28Ω

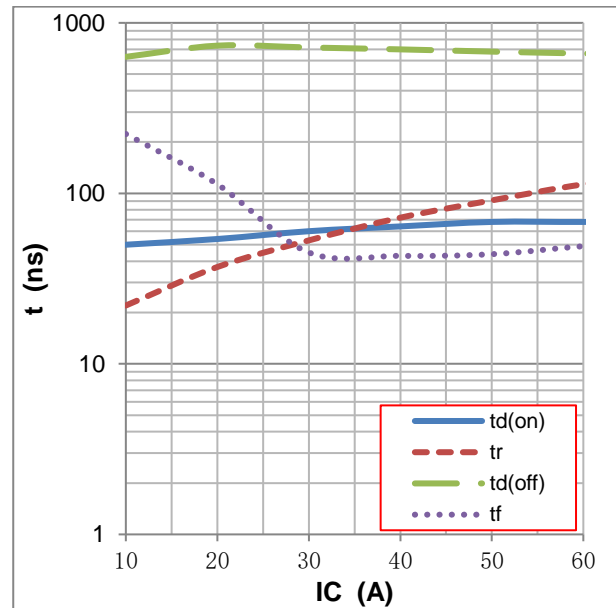

Figure10: typical switching time VS. IC, TC=25°C,

L=500uH, VCE=600V, VGE=15V, Rg=28Ω

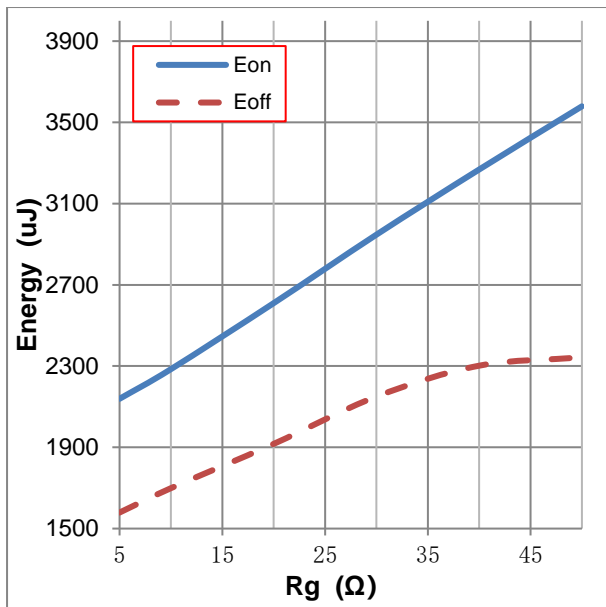

Figure11: typical energy loss VS. Rg, TC=25°C,

L=500uH, VCE=600V, VGE=15V, IC=50A

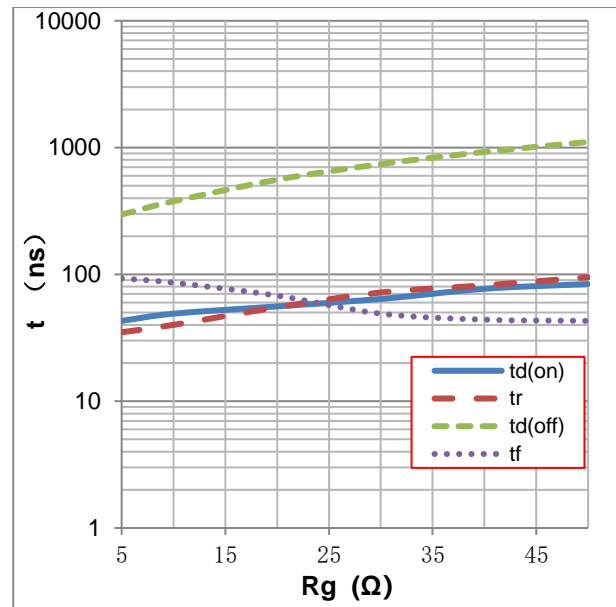

Figure12: typical switching time VS. Rg, TC=25°C,

L=500uH, VCE=600V, VGE=15V, IC=50A

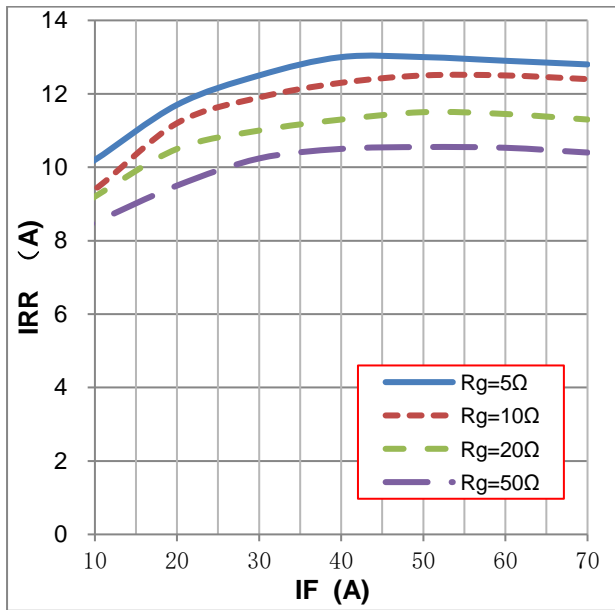

Figure13: typical diode IRR VS. IF, TC=25°C

VCC=600V, VGE=15V

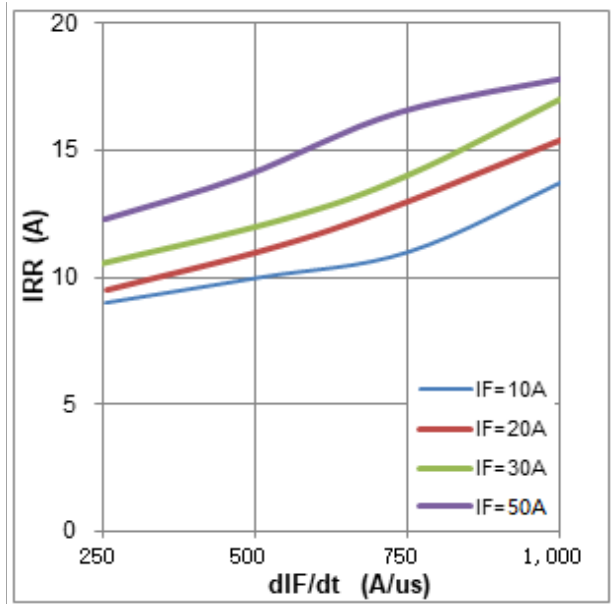

Figure14: typical diode IRR VS. dIF/dt

VCC=600V, VGE=15V

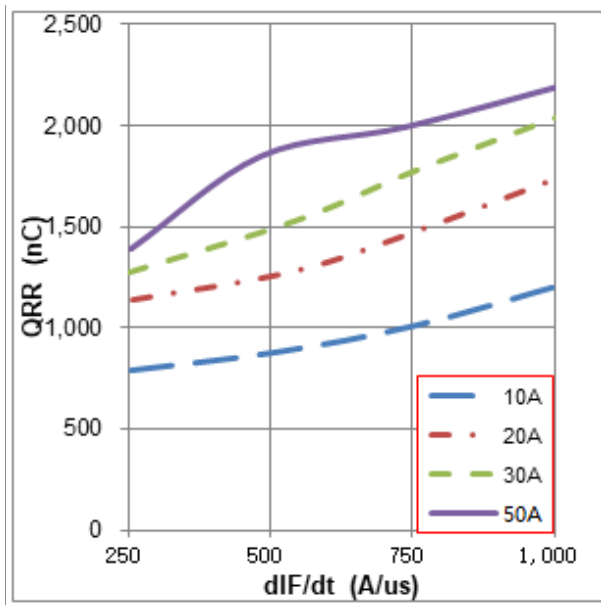

Figure15: typical diode QRR VS. dIF/dt

VCC=600V, VGE=15V

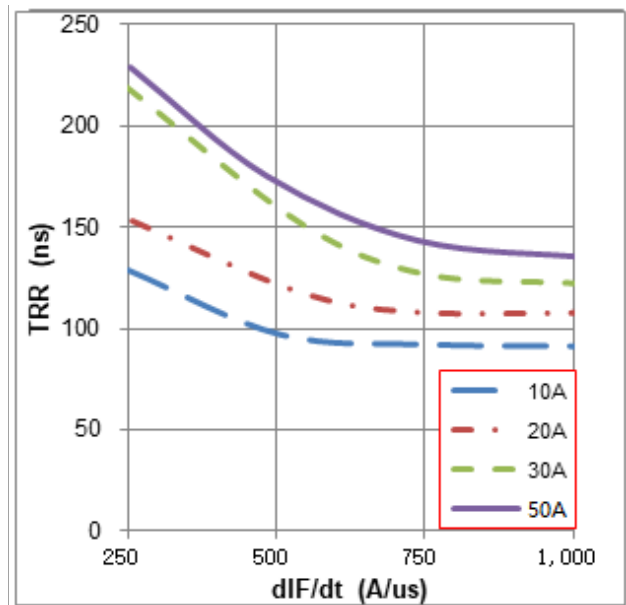

Figure16: typical diode TRR VS. dIF/dt,

VCC=600V, VGE=15V

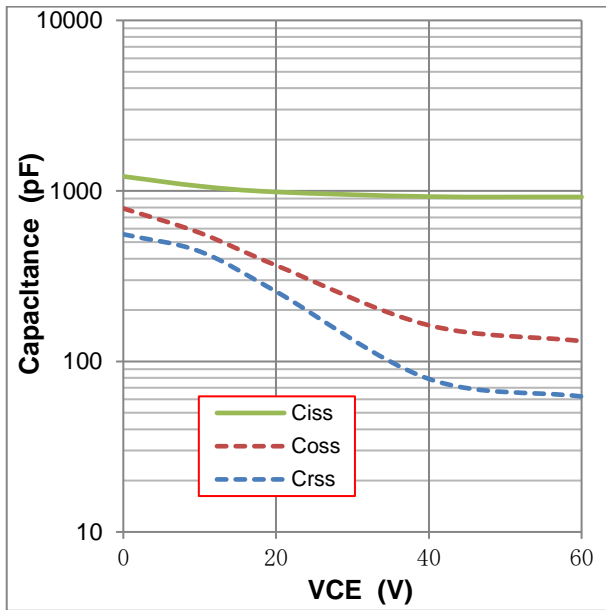

Figure17:typical capacitance VS. VCE,VGE=0V,f=100kHz

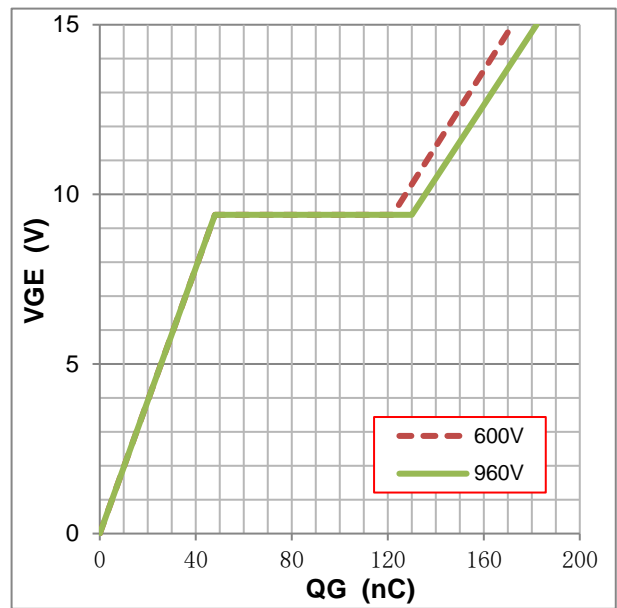

Figure18:typical gate charge VS. VGE,IC=50A

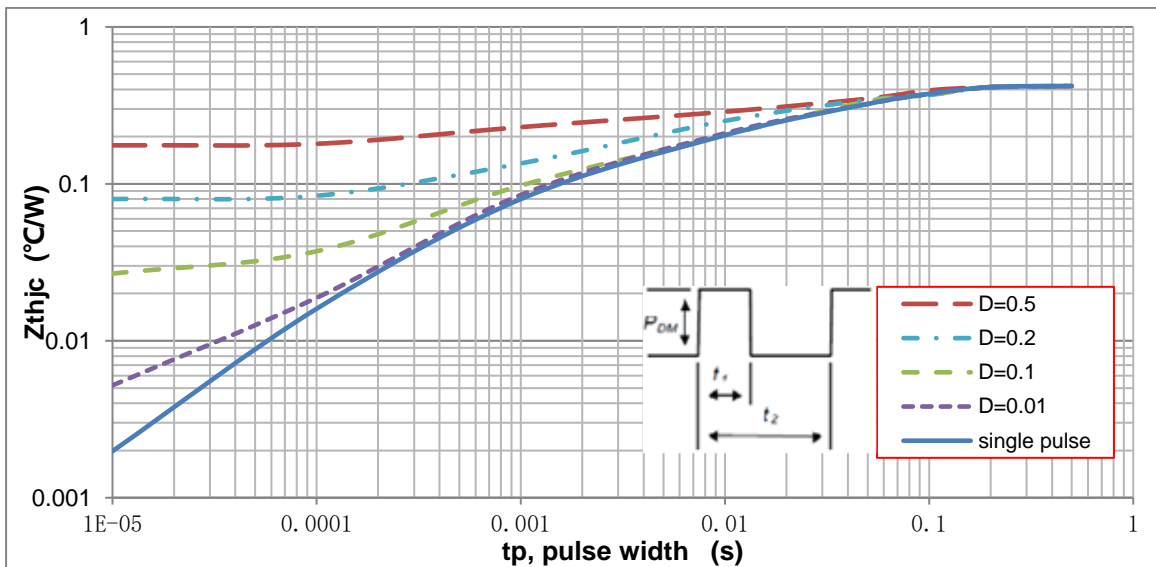
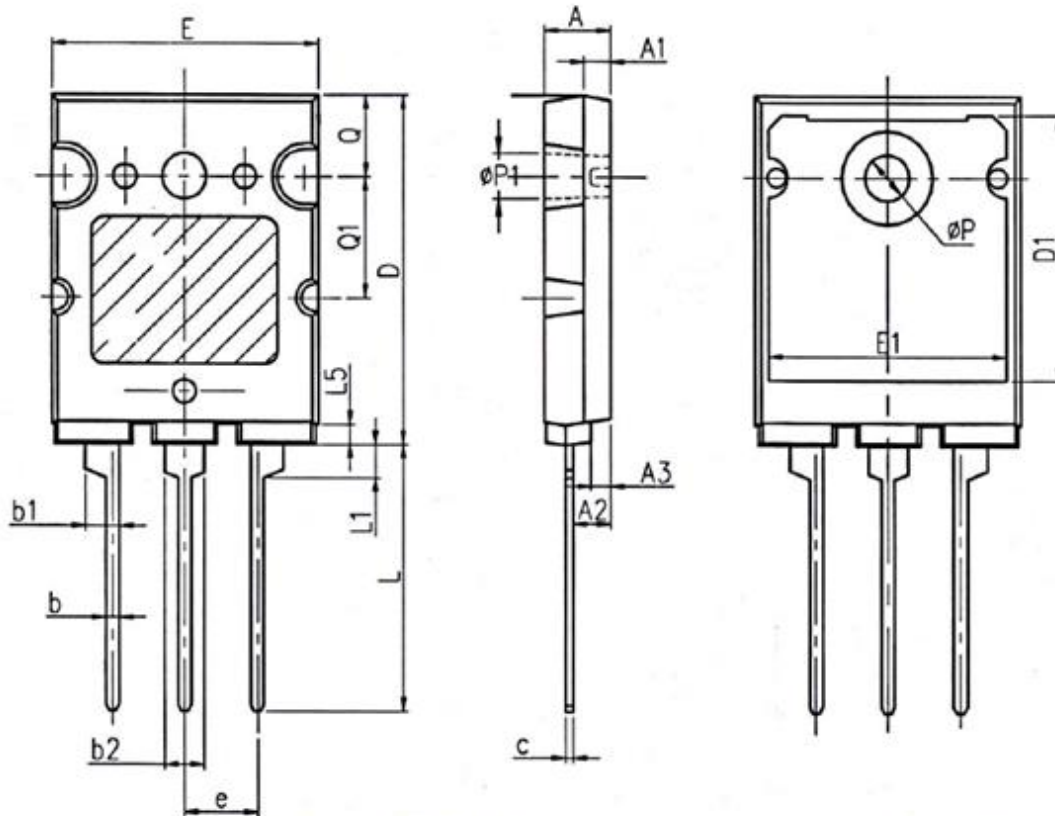

Figure19:normalised transient thermal impedance, junction-to-case

Note1.Duty factor $D=t_1/t_2$; Note2:peak $T_J=P_{DM} \times Z_{thjc} + T_C$

封装外形

SYMBOL	DIM			SYMBOL	DIM		
	MIN	NOM	MAX		MIN	NOM	MAX
A	4.80	5.00	5.20	E	19.50	20.00	20.50
A1	2.00 REF			E1	16.00	-	-
A2	2.50	2.80	3.10	e	5.45 TYP		
A3	1.50 REF			L	19.50	20.00	20.50
b	0.90	1.00	1.25	L1	2.30	2.50	2.70
b1	2.30	2.50	2.75	L5	1.35 REF		
b2	2.80	3.00	3.20	ΦP	3.00	3.20	3.40
c	0.50	0.60	0.85	$\Phi P1$	3.20	3.40	3.60
D	25.70	26.00	26.30	Q	5.80	6.00	6.20
D1	19.00	-	-	Q1	8.80	9.00	9.20

Disclaimers

JIAEN Semiconductor Co., Ltd reserves the right to make changes without notice in order to improve reliability, function or design and to discontinue any product or service without notice. Customers should obtain the latest relevant information before orders and should verify that such information is current and complete. All products are sold subject to JIAEN's terms and conditions supplied at the time of order acknowledgement.

JIAEN Semiconductor Co., Ltd warrants performance of its hardware products to the specifications at the time of sale, Testing, reliability and quality control are used to the extent JIAEN deems necessary to support this warrantee. Except where agreed upon by contractual agreement, testing of all parameters of each product is not necessarily performed.

JIAEN Semiconductor Co., Ltd does not assume any liability arising from the use of any product or circuit designs described herein. Customers are responsible for their products and applications using JIAEN's components. To minimize risk, customers must provide adequate design and operating safeguards.

JIAEN Semiconductor Co., Ltd does not warrant or convey any license either expressed or implied under its parent rights, nor the rights of others. Reproduction of information in JIAEN's datasheets or data books is permissible only if reproduction is without modification or alteration. Reproduction of this information with any alteration is an unfair and deceptive business practice. JIAEN Semiconductor Co., Ltd is not responsible or liable for such altered documentation.

Resale of JIAEN's products with statements different from or beyond the parameters stated by JIAEN Semiconductor Co., Ltd for that product or service voids all express or implied warranties for the associated JIAEN's product or service and is unfair and deceptive business practice. JIAEN Semiconductor Co., Ltd is not responsible or liable for any such statements.